

JENSEN®

**HOME AUDIO SYSTEM WITH
3 CD CHANGER,
BELT-DRIVE TURNTABLE,
DUAL CASSETTE DECK AND
REMOTE CONTROL**



OWNER'S MANUAL JMC-1000

PLEASE READ THIS OPERATING MANUAL COMPLETELY BEFORE OPERATING THIS UNIT
AND RETAIN THIS BOOKLET FOR FUTURE REFERENCE.

DEAR JENSEN® CUSTOMER

Selecting fine audio equipment such as the unit you've just purchased is only the start of your musical enjoyment. Now it's time to consider how you can maximize the fun and excitement your equipment offers. This manufacturer and the Electronic Industries Association's Consumer Electronics Group want you to get the most out of your equipment by playing it at a safe level. One that lets the sound come through loud and clear without annoying blaring or distortion and, most importantly, without affecting your sensitive hearing.

Sound can be deceiving. Over time your hearing "comfort level" adapts to higher volumes of sound. So what sounds "normal" can actually be loud and harmful to your hearing. Guard against this by setting your equipment at a safe level BEFORE your hearing adapts.

To establish a safe level:

- Start your volume control at a low setting.
- Slowly increase the sound until you can hear it comfortably and clearly, and without distortion.

Once you have established a comfortable sound level:

- Set the dial and leave it there.

Taking a minute to do this now will help to prevent hearing damage or loss in the future. After all, we want you listening for a lifetime.

We Want You Listening For a Lifetime

Used wisely, your new sound equipment will provide a lifetime of fun and enjoyment. Since hearing damage from loud noise is often undetectable until it is too late, this manufacturer and the Electronic Industries Association's Consumer Electronics Group recommend you avoid prolonged exposure to excessive noise.

Customer's Record:

The serial number of this product is found on its back cover. You should note the serial number of this unit in the space provided as a permanent record of your purchase to aid in identification in the event of theft or loss.

Model Number: JMC-1000

Serial Number: _____

IMPORTANT SAFETY INSTRUCTIONS



The lightning flash with arrow-head symbol, within an equilateral triangle is intended to alert the user to the presence of uninsulated dangerous voltage within the product's enclosure that may be of sufficient magnitude to constitute a risk of electric shock to persons.

CAUTION

RISK OF ELECTRIC SHOCK
DO NOT OPEN

WARNING: TO REDUCE THE RISK OF ELECTRIC SHOCK DO NOT REMOVE COVER (OR BACK), NO USER SERVICEABLE PARTS INSIDE REFER SERVICING TO QUALIFIED SERVICE PERSONNEL.



The exclamation point within an equilateral triangle is intended to alert the user to the presence of important operating and maintenance (servicing) instructions in the literature accompanying the appliance.

"See Back of Unit"

WARNING: To reduce the risk of fire or electric shock, do not expose this apparatus to rain or moisture.

THE IMPORTANT SAFETY INSTRUCTIONS SHALL INCLUDE, AS APPLICABLE TO THE APPLIANCE, STATEMENTS THAT CONVEY TO THE USER THE INFORMATION ITEMIZED IN THIS PARAGRAPH:

1. Read these instructions - All the safety and operating instructions should be read before the appliance is operated
2. Keep these instructions - The safety and operating instructions should be kept for future reference.
3. Heed all warnings - All warnings on the appliance and in the operating instructions should be adhered to.
4. Follow all instructions - All operation and use instructions should be followed.
5. Do not use this apparatus near water - The appliance should not be used near water; for example, near a bathtub, washbowl, kitchen sink, laundry tub, in a wet basement, or near a swimming pool, and the like.
6. Clean only with dry cloth - The appliance should be cleaned only as recommended by the manufacturer.
7. Do not block any ventilation openings. Install in accordance with the manufacturer's instructions. - The appliance should be situated so that its location or position does not interfere with its proper ventilation. For example, the appliance should not be situated on a bed, sofa, rug, or similar surface that may block the ventilation openings; or placed in a built-in installation, such as a bookcase or cabinet that may impede the flow of air through the ventilation openings.
8. Do not install near any heat sources such as radiators, heat registers, stoves or other apparatus (including amplifiers) that produce heat.
9. Do not defeat the safety purpose of the polarized or grounding-type plug. A polarized plug has two blades with one wider than the other. A grounding type has two blades and a third grounding prong. The wide blade or the third prong are provided for your safety. If the provided plug does not fit into your outlet, consult an electrician for replacement of the obsolete outlet.
10. Protect the power cord from being walked on or pinched particularly at plugs, convenience receptacles, and the point where they exit from the apparatus.
11. Only use attachments / accessories specified by the manufacturer
12. Use only with the cart, stand, tripod, bracket, or table specified by the manufacturer, or sold with the apparatus. When a cart is used, use caution when moving the cart/apparatus combination to avoid injury from tip-over.



13. Unplug this apparatus during lightning storms or when unused for a long periods of time.
14. Power Sources - The appliance should be connected to a power supply only of the type described in the operating instructions or as marked on the appliance. Do not overload wall outlet.
15. Wall and Ceiling Mounting - The appliance should be mounted to a wall or ceiling only as recommended by the manufacturer.
16. Power Lines - An outdoor antenna should be located away from power lines.
17. Object and Liquid Entry - Care should be taken so that objects do not fall and liquids are not spilled into the enclosure through openings.
18. Refer all servicing to qualified service personnel. Servicing is required when the apparatus has been damaged in any way, such as power-supply cord or plug is damaged, liquid has been spilled or objects have fallen into the apparatus, the apparatus has been exposed to rain or moisture, does not operate normally, or has been dropped.
19. Servicing - The user should not attempt to service the appliance beyond that described in the operating instructions. All other servicing should be referred to qualified service personnel.

CAUTION:

TO PREVENT ELECTRIC SHOCK, MATCH WIDE BLADE OF PLUG TO WIDE SLOT. FULLY INSERT THE PLUG TO MAIN POWER SOCKET.



CLASS 1 LASER PRODUCT

CLASS 1 LASER PRODUCT
 APPAREIL LASER DE CLASSE 1
 PRODUCTO LASER DE CLASE 1

CAUTION
 INVISIBLE LASER RADIATION
 WHEN OPEN AND INTERLOCKS
 DEFEATED.
 AVOID EXPOSURE TO BEAM



This product contains a low power Laser Device.

Note: This product complies with DHHS Rule 21 Subchapter J at date of manufacture.

Follow the advice below for safe and appropriate operation.

ON PROTECTION AGAINST LASER ENERGY EXPOSURE

- As the laser beam used in this compact disc player is harmful to the eyes, do not attempt to disassemble the casing.
- Stop operation immediately if any liquid or solid object should fall into the cabinet.
- Do not touch the lens or poke at it. If you do, you may damage the lens and the player may not operate properly.
- Do not put anything in the safety slot. If you do, the laser diode will be ON when the CD door is still open.
- This unit employs a laser. The use of controls or adjustment or performance of procedures other than those specified here may result in exposure to hazardous radiation.

COMPLIANCE WITH FCC REGULATIONS

This device complies with Part 15 of the FCC Rules. Operation is subject to the following two conditions:

- (1) this device may not cause harmful interference, and
- (2) this device must accept any interference received, including interference that may cause undesired operation.

NOTE : This equipment has been tested and found to comply with the limits for a Class B digital device, pursuant to Part 15 of the FCC Rules. These limits are designed to provide reasonable protection against harmful interference in a residential installation. This equipment generates, uses and can radiate radio frequency energy and, if not installed and used in accordance with the instructions, may cause harmful interference to radio communications. However, there is no guarantee that interference will not occur in a particular installation. If this equipment does cause harmful interference to radio or television reception, which can be determined by turning the equipment off and on, the user is encouraged to try to correct the interference by one or more of the following measures:

- Reorient or relocate the receiving antenna.
- Increase the separation between the equipment and receiver.
- Connect the equipment into an outlet on a circuit different from that to which the receiver is connected.
- Consult the dealer or an experienced radio/TV technician for help.

CAUTION: Changes or modifications not expressly approved by the party responsible for compliance could void the user's authority to operate the equipment.

PREPARATION FOR USE

SPEAKER CONNECTION

Connect each speaker to the corresponding speaker terminals on the back panel of the main unit. Make sure that the **left** speaker is connected to the left (**L**) speaker jack and the **right** speaker to the right (**R**) speaker jack.

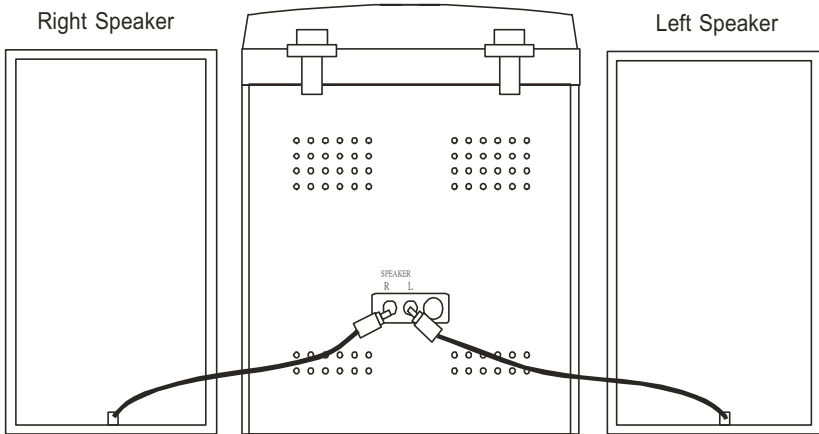

CONNECTING THE AC POWER CORD

After connecting the speakers unwind the AC power cord fully and connect it to any convenient household AC outlet.

NOTE:

This product is designed to operate on normal 120V 60Hz AC only. Connecting this system to any other power supply could result in damage to the unit which is not covered by your warranty. You will note that this system is equipped with a polarized AC power plug having one blade wider than the other. This is a safety feature.

If this plug does not fit into your existing AC outlet, do not try to defeat this safety feature by filing the wide blade to make it fit into your outlet. If this plug will not fit into your outlet, you probably have an outdated non-polarized AC outlet. You should have your outlet changed by a qualified licensed electrician.

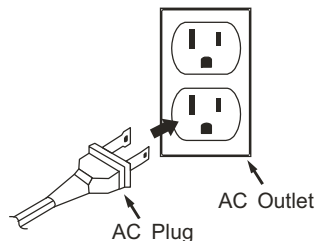

PROTECT YOUR FURNITURE !!

This model is equipped with non-skid rubber 'feet' to prevent the product from moving when you operate the controls. These 'feet' are made from non-migrating rubber material specially formulated to avoid leaving any marks or stains on your furniture. However certain types of oil based furniture polishes, wood preservatives, or cleaning sprays may cause the rubber 'feet' to soften, and leave marks or a rubber residue on the furniture. To prevent any damage to your furniture we strongly recommend that you purchase small self-adhesive felt pads, available at hardware stores and home improvement centers everywhere, and apply these pads to the bottom of the rubber 'feet' before you place the product on fine wooden furniture.





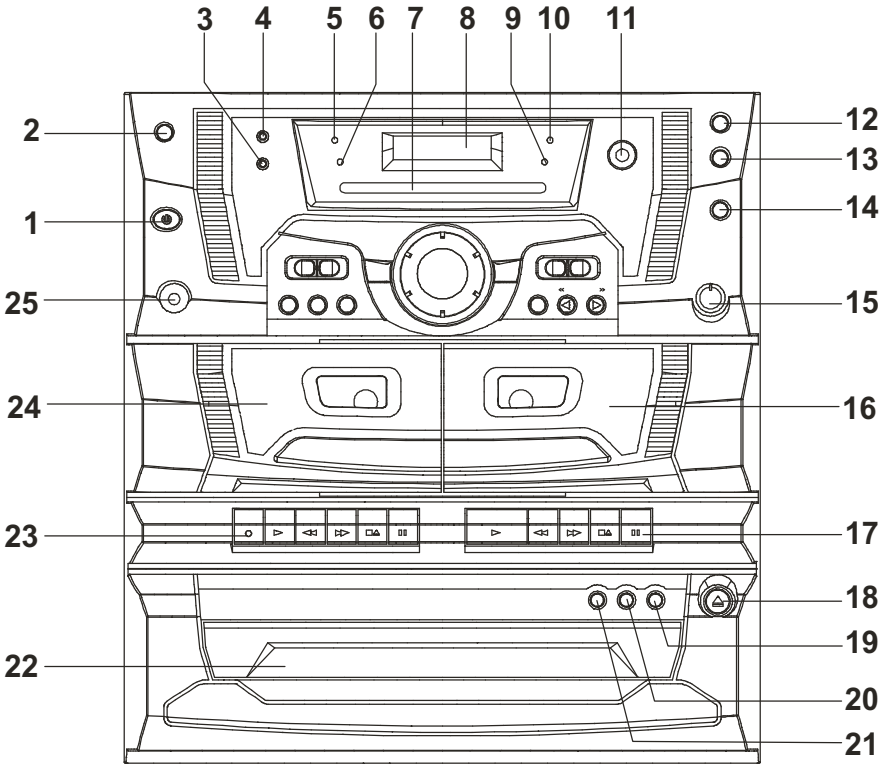

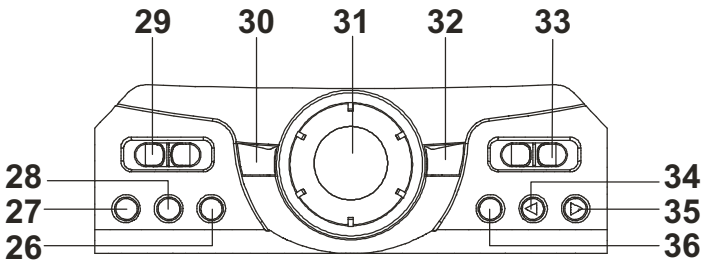

LOCATION OF CONTROLS AND INDICATORS

FRONT VIEW



CONTROL PANEL



- 1.) POWER  On/Off Button.
- 2.) PRESET EQ Button.
- 3.) FM STEREO Indicator.
- 4.) STANDBY/MUTE Indicator.
- 5.) ROCK Equalizer Indicator.
- 6.) POP Equalizer Indicator.
- 7.) Dial Scale.
- 8.) LCD Display.
- 9.) JAZZ Equalizer Indicator.
- 10.) CLASSIC Equalizer Indicator.
- 11.) Remote SENSOR.
- 12.) VOLUME UP Button.
- 13.) VOLUME DOWN Button.
- 14.) FM MONO/HI-SPEED DUBBING (ON  /OFF ) Button.
- 15.) BALANCE Control.
- 16.) Cassette DECK B Door.
- 17.) Cassette DECK B Control Keys.
- 18.) CD Tray Open/Close  Button.
- 19.) Disc 3 Select Button.
- 20.) Disc 2 Select Button.
- 21.) Disc 1 Select Button.
- 22.) CD Tray.
- 23.) Cassette DECK A Control Keys.
- 24.) Cassette DECK A Door.
- 25.) PHONES (Headphone) Jack.
- 26.) DISC SKIP Button.
- 27.) PROGRAM Button.
- 28.) REPEAT Button.
- 29.) FUNCTION (PHONO/TUNER/TAPE/CD) Selector Switch.
- 30.) STOP  Button.
- 31.) TUNING Control.
- 32.) CD PLAY/PAUSE  Button.
- 33.) BAND (FM/AM) Selector Switch.
- 34.) CD SKIP/SEARCH Reverse  Button.
- 35.) CD SKIP/SEARCH Forward  Button.
- 36.) INTRO Button.

BACK VIEW

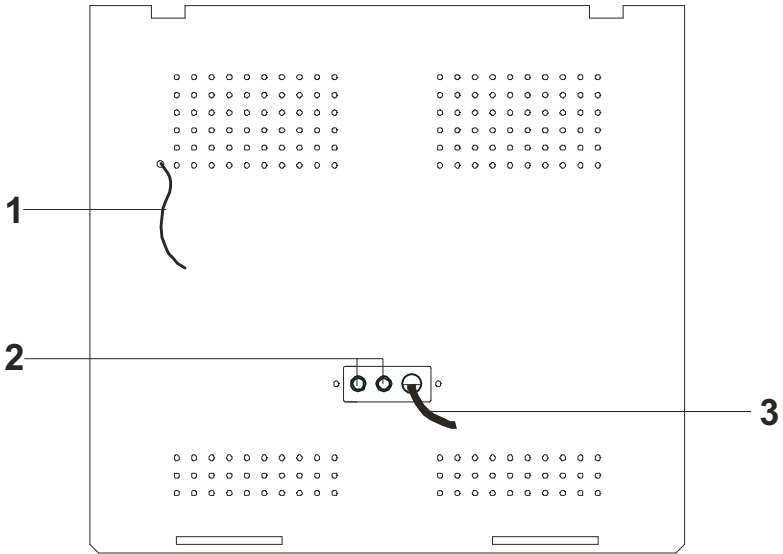

- 1.) FM Wire Antenna.
- 2.) Speaker L / R Jacks.
- 3.) AC Power Cord.

REMOTE CONTROL

- 1.) STANDBY/ON Button.
- 2.) STOP ■ Button.
- 3.) PROGRAM Button.
- 4.) CD PLAY/PAUSE ►|| Button.
- 5.) CD SKIP/SEARCH ►► Button.
- 6.) CD SKIP/SEARCH ◄◄ Button.
- 7.) DISC Select Button.
- 8.) MUTE Button.
- 9.) VOLUME - Button.
- 10.) VOLUME + Button.
- 11.) Battery Compartment (Back Cabinet).

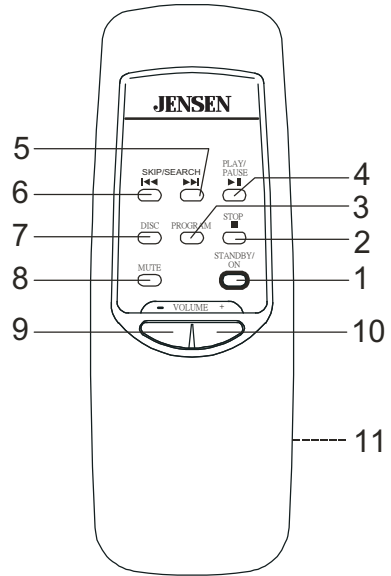

BATTERY INSTALLATION

- 1.) Open the battery compartment cover.
- 2.) Insert two "AAA" (UM4) batteries (not included) to match the polarities as indicated inside the battery compartment.
- 3.) Close the cover.

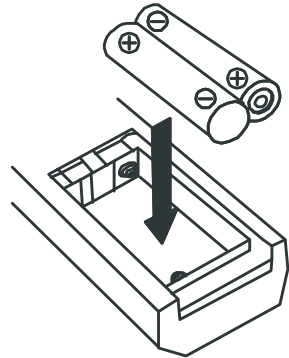

Battery Precautions

- Replacement of batteries must be done by an adult.
- Do not mix old and new batteries.
- Do not mix alkaline, standard (carbon-zinc) or rechargeable (nickel-cadmium) batteries.
- The supply terminals are not to be short-circuited.
- Non-rechargeable batteries are not to be recharged.
- Exhausted batteries are to be removed.
- Only batteries of the equivalent type are to be used.
- Batteries are to be inserted with the correct polarity.
- Dispose of batteries properly. Do not dispose of batteries in fire. The batteries may explode or leak.

OPERATING INSTRUCTIONS

GENERAL CONTROLS

Preset Electronic Equalizer

When the unit is switched "On" for the first time, the Equalizer will be in the "Flat" setting. Press the PRESET EQ button repeatedly to select "ROCK", "POP", "CLASSIC" or "JAZZ" sound effect to suit your taste. The appropriate EQ Indicator lights to confirm your selection.





Mute Button (Remote Control Only)

To temporarily shut off the sound from the speakers press the MUTE button on the remote control. The STANDBY/MUTE indicator on front panel will flash and the sound will stop. Press the MUTE button again to cancel Mute and restore the sound. The MUTE indicator goes "Off".

Balance Control

This control adjusts the relative volume of the left and right speakers. When this control is set to the center-click position you will have equal volume from both speakers. If your normal listening position is closer to one of the two speakers, rotate this control to the left or to the right until the volume from both of the speakers sounds the same at your normal listening position.

FM Mono/Hi-Speed Dubbing ON / OFF Selector

This button is used to select between the FM STEREO and FM MONO operation modes (It is also used to select either  Normal Speed or  High Speed tape dubbing.) To receive FM Stereo broadcasts this switch must be set to the STEREO  position. However if you are listening to a distant or weak FM Stereo station and reception is unsatisfactory, setting the selector to the FM MONO  position may provide some improvement.

PHONES Jack

The Stereo Headphone Jack is located on the left front panel. Connect a set of stereo headphones (not included) to this jack for private listening without disturbing others. The speakers are automatically disconnected when headphones are connected to the headphone jack.

IMPORTANT: When using headphones always set the volume control to a low level before you put the headphones on. Then put the headphones on and gradually increase the volume to a comfortable listening level.

LISTENING TO THE RADIO

- 1.) Slide the FUNCTION selector to the TUNER position.
- 2.) Slide the BAND selector to the desired band, FM or AM.
- 3.) Tune to your desired station with the TUNING control. If you have tuned to a FM Stereo station the FM STEREO LED Indicator will light.
- 4.) Adjust the VOLUME control and EQ as desired.
- 5.) When you are finished listening press the POWER  button to shut the power "Off".

Antenna Information

AM - The AM antenna is inside the cabinet. IF AM reception is unsatisfactory try rotating the entire unit until you find the position that provides the best reception.

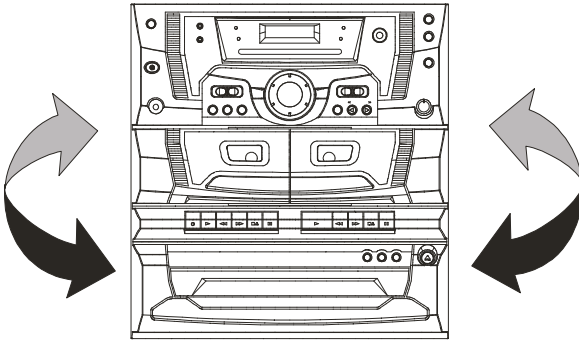

FM - For best FM reception, the FM lead wire antenna, located on the back of the set, should fully unwound and extended.

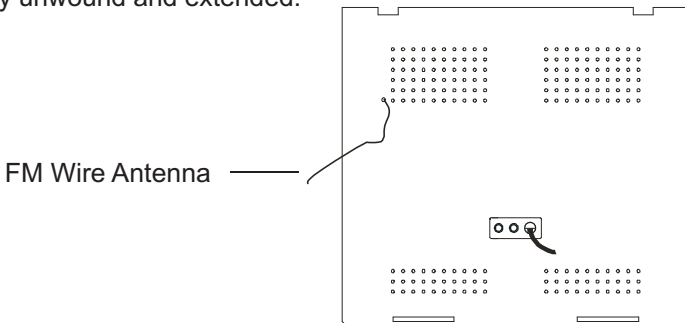



NOTE: If you are listening to a weak FM Stereo station you can usually improve the reception by pressing the FM MONO selector to the  ON position, however the sound will now be mono.

PLAYING COMPACT DISCS

IMPORTANT: This CD player can play normal CDs plus CD-R and CD-RW discs. However the playability of CD-R/RW discs may be affected by the type of software that was used in 'ripping' the tracks from the original discs and 'burning' the tracks onto the blank media. Playability may be affected by the quality and condition of the blank media you use for recording. 100% compatibility cannot be guaranteed. This is not an indication of any problems with your player.

This system features a carousel type 3-CD changer which can provide you with up to 3 hours of uninterrupted music playback. You may load up to 3 CDs in the changer for continuous playback, or you may program up to 32 tracks among all 3 discs to be played back in the specific order you select.

LOADING THE DISCS

- 1.) Press the POWER  button to turn the system "On".
- 2.) Slide the FUNCTION selector to the CD position.
- 3.) Press the  Open/Close button to open the CD tray. When the tray opens two of the three CD pockets will be accessible to you. Load up to 2 CDs in the pockets making sure that the label side of the discs face up and that the discs are correctly centered in the pockets.
- 4.) Press the DISC SKIP button to rotate the CD tray and expose the 3rd CD pocket. Insert an additional disc in the open pocket if desired.
- 5.) Press the  Open/Close button to close the CD tray. The CD player will search for the first disc and the display will show the number of tracks and total playing time of that disc.



NOTES:

- Keep the CD disc tray closed when the system is not in use to prevent dirt and dust from entering the CD mechanism.
- Never place more than one CD in the same pocket of the CD tray. If two discs are loaded in the same pocket, the CD mechanism may jam and /or the discs themselves may be damaged.

TO BEGIN CD PLAYBACK

After you have loaded up the 3 CDs in the changer:

- 1.) Press the PLAY/PAUSE ►|| button to begin playback. The changer will search for the first available disc in the tray and will begin playback from Track 1 on the first disc. The number of the disc being played flashes on the display. It will continue playing until it has played all of the discs in the tray and then stops automatically.



NOTE: To begin playback from a specific disc, press the DISC SKIP button on front panel or DISC button on remote control to select the desired disc, and then press the PLAY/PAUSE ►|| button. Or, press the appropriate disc button (DISC 1, DISC 2, DISC 3.) on front panel for the disc you wish to start. Playback will begin on Track 1 of the selected disc. It stops automatically after finished playing all discs.

- 2.) Adjust the VOLUME and EQ control as desired.
- 3.) To temporarily stop playback, press the PLAY/PAUSE ►|| button again. The "||" indicator appears in the display. The disc continues to spin, but no sound is heard. Press the PLAY/PAUSE ►|| button once more to cancel pause and resume playback.



- 4.) To stop playback before the end of a disc, press the STOP ■ button.

IMPORTANT!!

If the disc is smudged or scratched it may skip or stop completely. This does not indicate a problem with the player. If this occurs, try playing another disc. If that disc plays properly, you may assume that the first disc is damaged and unplayable.

Simultaneous Play and Load System

This CD changer allows you to change two discs while a third disc continues playing. Press the CD drawer ▲ Open/Close button during playback. The drawer will open, allowing you to remove two discs and insert two new discs, while the third disc continues to play. After loading two new discs in the tray press the ▲ Open/Close button to close the drawer.

SKIP/SEARCH ►► / ◀◀ Buttons

To skip forward or backward to the beginning of a particular track during playback, press the ►► or ◀◀ SKIP/SEARCH buttons repeatedly until the desired track number appears on the display. Playback will begin on the desired track.

To search for a particular passage on a track during playback, press and hold the ►► or ◀◀ SKIP/SEARCH buttons. The player will search rapidly forward or backward. Release the buttons when you reach the desired point on the track and normal speed playback will resume at that point.

NOTE: You can only skip tracks within the disc being played and cannot skip directly from first track to last track or vice versa.

PROGRAMMED CD PLAYBACK

You can program the CD changer to play up to a total of 32 tracks on all 3 discs in any desired order.

NOTE: You can not program the CD changer during playback. If a disc is playing press the STOP ■ button first and then follow the instructions.

- 1.) Press the PROGRAM button once. The PROGRAM, EDIT indicators, program # 01, disc # 01 appears in the display.

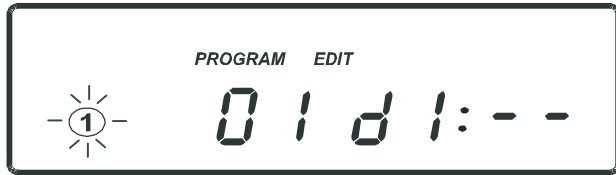

- 2.) Press the DISC SKIP button or one of the three DISC buttons to select the disc which contains the first track you wish to program. Example: Disc 2.

- 3.) Press the ►► or ◀◀ buttons to select the first track you wish to program.

Example: Track 8.

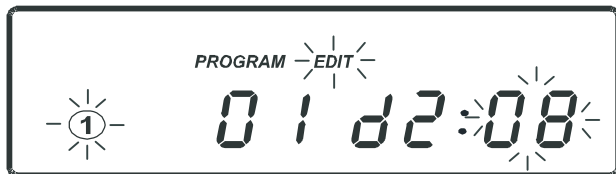

- 4.) Press the PROGRAM button again to store the desired disc and track number into memory location Number 1. The display will change from Program Number 01 to Program Number 02 .

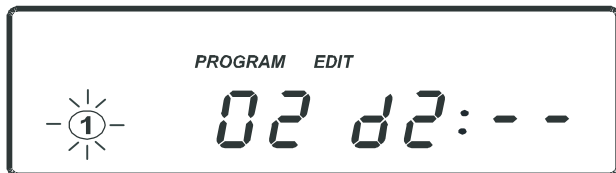

- 5.) Use the DISC SKIP button or one of the three DISC buttons to select the disc containing the next track you wish to program. Example: Disc 3.
- 6.) Press the ►► or ◀◀ buttons to select the next track you wish to program. Example: Track 18.



- 7.) Press the PROGRAM button again to store the desired disc and track into memory location Number "02".

Repeat the above procedure until you have stored up to 32 tracks in the program memory.

After all your desired tracks are programmed you may press the PROGRAM button to reconfirm that the information has been stored correctly.

- 8.) Press the PLAY/PAUSE ►► button to begin programmed playback. Playback will start at the first disc and track which you have programmed and will continue until all programmed discs and tracks (up to a total of 32) have been played.

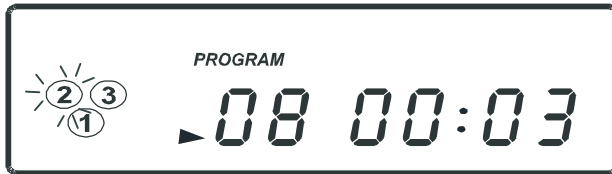

- 9.) Press the PROGRAM button and then press the PLAY/PAUSE ►► button if you want to listen the programmed tracks again.

NOTE: If you press the ►► or ◀◀ buttons during programmed playback, the player will skip forward or backward to the next track and disc which you have programmed, but not the next track in sequence of the disc which is being played.

TO CLEAR THE PROGRAM MEMORY

If the disc is playing, press the STOP ■ button to stop the discs. Then press the PROGRAM button and then press the STOP ■ button again, switch the FUNCTION selector to other position, or turn power "Off" to clear the program memory.

REPEAT Playback (On Front Panel Only)

This system has a four-way repeat function which allows you to continuously repeat one track, one disc, all discs, or all of the tracks which you have programmed.

One Track Repeat

- 1.) Press the REPEAT button until the "REPEAT 1" Indicator appears in the CD display.
- 2.) Use the ►► or ◀◀ buttons (and the "DISC SKIP" button, if necessary) to select the exact track that you wish to repeat.
- 3.) Press the PLAY/PAUSE ►|| button to begin one track repeat. The selected track will begin playing. It will repeat continuously until repeat function is cancelled.
- 4.) To cancel One Track Repeat, press the REPEAT button until the indicator no longer appears in the display.



One Disc Repeat

- 1.) Press the REPEAT button until the "REPEAT 1 DISC" Indicator appears on the display. Press the DISC SKIP button to select the disc you wish to play.
- 2.) Press the PLAY/PAUSE ►|| button. The selected disc will begin to play starting with Track 1. When the final track on the disc has been played, it will automatically begin playing again starting with Track 1.



- 3.) To cancel One Disc Repeat playback, press the REPEAT button until the indicator no longer appears in the Display.

All Discs Repeat

- 1.) Press the REPEAT button until the "REPEAT ALL DISC" Indicator appears in the Display.
- 2.) Press the PLAY/PAUSE ►|| button, the changer will begin playing the first track of the disc which is in the play position. It will continue until it has played all tracks on all discs in the changer. When it has played the last track on the last disc it will begin playing again with the first track on the first disc. This All Discs Repeat will continue indefinitely.



- 3.) To cancel All Discs Repeat playback, press the REPEAT button until the Indicator no longer appears in the Display.

Programmed Repeat Playback

You can use the Program and Repeat features together to continuously repeat a programmed sequence of tracks. First, program the desired tracks according to Steps 1 through 7 in previous page. When Programmed Playback begins press the REPEAT button until the "REPEAT ALL DISC" Indicator appears in display. All the tracks in your programmed sequence will be repeated continuously.

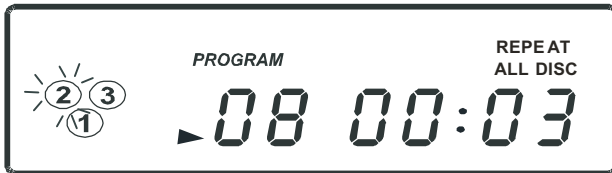

To cancel Programmed Repeat Playback press the STOP ■ button until both the PROGRAM and REPEAT Indicators go "Off".

INTRO Scan (On Front Panel Only)

The Intro Scan feature lets you hear a 10 second introduction of each track on each disc. This feature is useful if you are trying to find a particular song but you do not know the title.

- 1.) Press the INTRO button once. The "INTRO" and "ALL DISC" Indicators appear in the display. The CD player will begin playing Track 1 of the disc in the play position. After 10 seconds it will advance to Track 2, and so on, until it has played the first 10 seconds of every track. Then it continues to next disc until all discs has been played.



- 2.) To cancel Intro Scan and resume normal playback, press the INTRO button again. The INTRO Indicator disappears.

NOTES:

1. Because of non-standardized format definition/production of CD-R/RW, playback quality and performance are not guaranteed.
2. Manufacturer is not responsible for playability of CD-R/RW due to recording conditions such as PC performance, writing software, media ability, etc.
3. Do not attach a label or seal to either side of CD-R/RW disc. It may cause a malfunction.

TURNTABLE

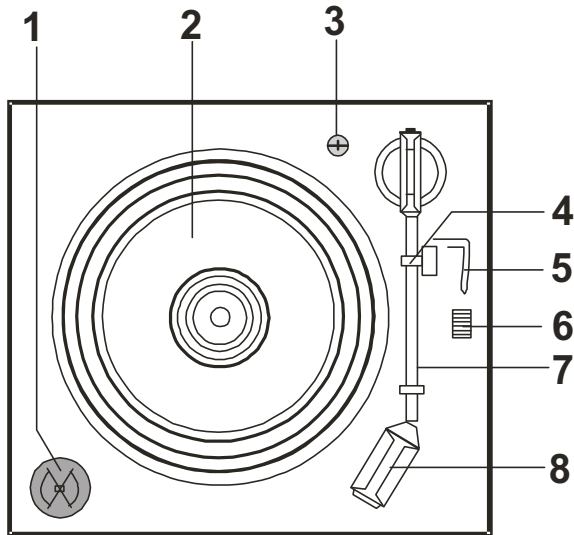

- 1.) 45 rpm LP Record Adapter.
- 2.) Platter.
- 3.) Transit Screw.
- 4.) Tone Arm Clamp.
- 5.) Tone Arm Lever (Cue Control).
- 6.) 33/45/78 rpm Speed Slide Switch.
- 7.) Tone Arm.
- 8.) Stylus and Protective Cover.

IMPORTANT!!

TO PROTECT THE TURNTABLE FROM DAMAGE DURING TRANSPORTATION, A SILVER TRANSIT SCREW IS LOCATED AT THE UPPER HAND CORNER OF THE TURNTABLE PLATFORM.

BEFORE PLAYING, PLEASE USE A SCREWDRIVER TO TURN THE TRANSIT SCREW IN CLOCKWISE DIRECTION (SCREW GOING DOWN) COMPLETELY TO UNLOCK THE TURNTABLE.

TO LOCK THE TURNTABLE AGAIN FOR TRANSPORTATION, PLEASE TURN THE SCREW IN COUNTER-CLOCKWISE DIRECTION.

STEREO PHONOGRAPH OPERATION



- 1.) Raise the turntable dust cover.
- 2.) Release the Tone Arm Clamp, and remove the stylus protector.
- 3.) Slide FUNCTION selector to PHONO position.
- 4.) Place a record on the turntable, over the central spindle.
- 5.) Place the 45 rpm adapter over the central spindle when playing 45 rpm records. Set the Speed Selector Switch to 33, 45 or 78 rpm according to the record you are playing.
- 6.) Move the Tonearm to the beginning of the record, or to the start of a particular track. Gently lower the Tonearm onto the record to start playing. Adjust the Volume and Equalizer setting as desired.
- 7.) To pause during playback use the Cue Control lever to lift the Tone Arm from the record. To resume playback gently move the Cue Control forward to lower the Tone Arm back on to the record.
- 8.) At the end of the record the Tone Arm will automatically return to its rest and the turntable stops, however the system power is still "On".
- 9.) If you are finished playing records press the POWER  button to shut the system Off , or use the FUNCTION selector switch to select a different function.
- 10.) Lock the Tone Arm Clamp.

NOTE:





1. Do not turn or stop the turntable manually. Moving or jarring the Turntable without securing the Tone Arm clamp could result in damage to the Tone Arm.
2. Recommend you replace the stylus protector after finish listening each time.

CASSETTE OPERATION

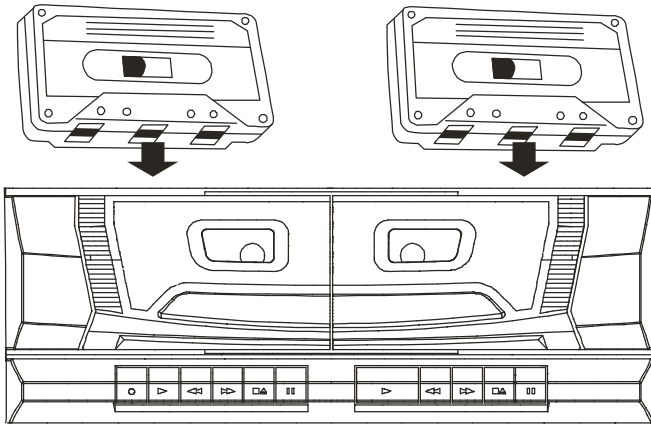



PLAYING CASSETTE TAPES



- 1.) Press the POWER  button to turn the system "On".
- 2.) Slide the FUNCTION selector to TAPE position to select the Tape mode.
- 3.) Press the Stop/Eject  key of either deck A or deck B cassette control to open the cassette door.
- 4.) Insert a prerecorded cassette into the slots on the door with the exposed tape facing down and the full reel on the left side. Close cassette door.





- 5.) Press the Play  key to begin playback.
- 6.) Adjust the VOLUME and EQ controls as desired.
- 7.) When the tape ends the Automatic Stop System releases the Play  key and shuts off the tape motor. Press the Stop/Eject  key to open the cassette door and remove your tape. To stop the tape before it ends press the Stop/Eject  key at any time.

Fast Forward and Rewind Controls





Press  or  key to advance or rewind the tape rapidly. When you reach the desired portion, or the end of the tape, press the Play  key to resume normal playback, or press the Stop/Eject  key to shut off the tape motor.

Note: the Automatic Stop System does not function in the fast forward  or rewind  modes.

Pause Control

Press the  key to stop the tape temporarily. The tape movement stops but the tape motors continue to run. Press the  key again to cancel pause mode and resume normal playback.

CONTINUOUS PLAYBACK OF TWO CASSETTES

- 1.) Insert prerecorded tapes into both cassette compartments with the tape you want to play first in DECK B.
- 2.) Press the Play  key of DECK B to begin playback.
- 3.) Press Pause  key and then Play  key of DECK A.
- 4.) When the tape in DECK B ends, it stops and the Pause  key of DECK A will be released automatically to begin playback on DECK A.

NOTE: Continuous playback no function if you play the tape in DECK A first.

MAKING A TAPE RECORDING

This cassette recorder features an Automatic Recording Volume Level Control System that prevents overloaded or distorted recordings. You can change the volume level as often as you like during the recording process. It will not have any effect on the volume level of the recording itself.

- 1.) Insert a good quality blank tape into DECK A with the exposed tape facing down and the full reel on the left side. Close DECK A door.

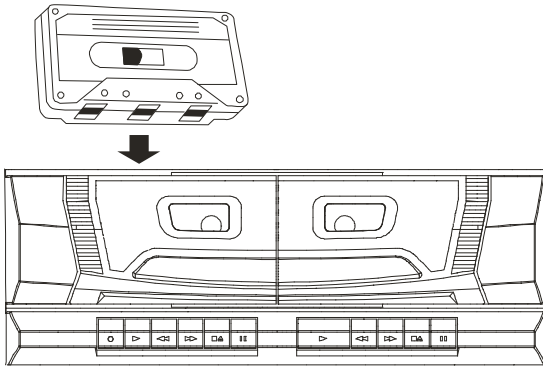

- 2.) Select the source you wish to record:

PHONO, TUNER, CD or TAPE (Tape Dubbing) and operate that source as you normally would.

- 3.) Press the Record ● key on DECK A to begin recording.

NOTE: When recording from Cassette B to Cassette A you can press the HI-SPEED DUBBING button to "ON ■" to select high speed dubbing which allows you to make recordings at approximately twice the normal recording speed.

CARE AND MAINTENANCE

1. Do not subject the unit to excessive force, shock, dust or extreme temperature.
2. Do not tamper the internal components of the unit.
3. Clean your unit with a dry cloth. Solvent or detergent should never be used.
4. Avoid leaving your unit in direct sunlight or in hot, humid or dusty places.
5. Keep your unit away from heating appliances and sources of electrical noise such as fluorescent lamps or motors.

ABOUT CASSETTE TAPES

Whenever you record on a cassette any previously recorded material is erased as the new material is recorded. To prevent you from accidentally erasing material which you wish to save, blank cassettes are equipped with erase prevention tabs for each side of the tape. If the erase prevention tab for side A is removed, you cannot accidentally record on side A. The Record ● key cannot be depressed if the erase prevention tab on the cassette has been removed.

To prevent accidental erasing on side A of a cassette use a small screw driver or similar tool to break off the erase prevention tab for side A. This prevents the record key from locking.

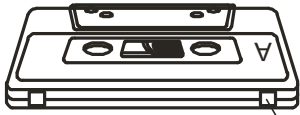

TAB FOR SIDE A.

BREAK OFF TO PREVENT RECORDING

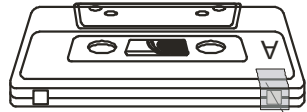

COVER OPENING WITH TAPE
IN ORDER TO RECORD AGAIN.

If later you do wish to record on side A of the cassette, cover the tab opening with a piece of cellophane tape. This will allow the Record ● key to function again.

CASSETTE CARE

Two common causes of trouble experienced when using cassettes are:

- 1.) Tape jamming - Leading to uneven speed in playback, and
- 2.) Tape tangling - Where the tape wraps itself around vital parts of the mechanism.

To reduce the likelihood of these problems occurring, the following precautions should be observed:

Check that there are no loose layers of tape visible through the cassette center window (see Fig. 1). Take up any loose layers, using a pencil or hexagonal barrelled ballpoint pen, before inserting the cassette into the machine (see Fig. 2).

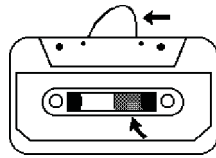

Fig.1

- If the cassette feels tight while performing operation shown (see Fig. 2), the tape may be jamming due to ridges formed in the winding of the tape (visible through the center window). These may be removed, in most cases, by fast winding of the cassette from one end to the other and back again.

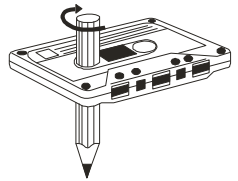

Fig. 2

- Use only well-known brands of tape. Avoid use of C-120 cassettes.

Furthermore, do not expose cassettes to direct sunlight, dust or oil, and do not touch the tape surfaces.

HEAD CLEANING

The tape heads, pinch roller and capstan require periodic cleaning. This removes particles of the metal oxide coating that wear off the tape and accumulate on these parts and impair performance. Switch off the power, press the Stop/Eject $\blacksquare \blacktriangle$ key to open the cassette door, and press the Play \blacktriangleright key. Clean the tape heads, pinch roller and capstan with a soft cloth or cotton pad dampened in isopropyl alcohol or special tape head cleaner.

DECK A

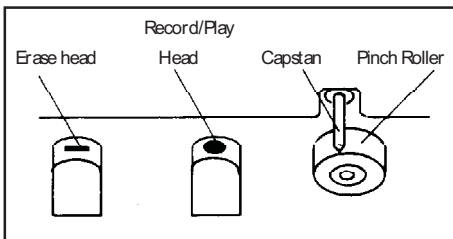

DECK B

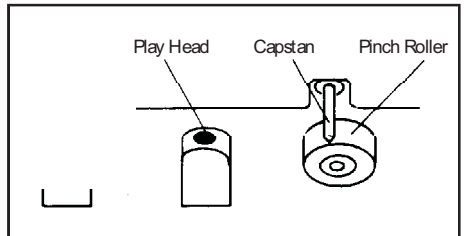

COMPACT DISC CARE

- To remove a disc from its storage case, press down on the center of the case and lift the disc out, holding it carefully by the edges.



- Fingerprints and dust should be carefully wiped off the disc's recorded surface with a soft cloth. Unlike conventional records, compact discs have no grooves to collect dust and microscopic debris, so gently wiping with a soft cloth should remove most particles. Wipe in a straight line from the inside to the outside of the disc. Small dust particles and light stains will have absolutely no effect on reproduction quality.

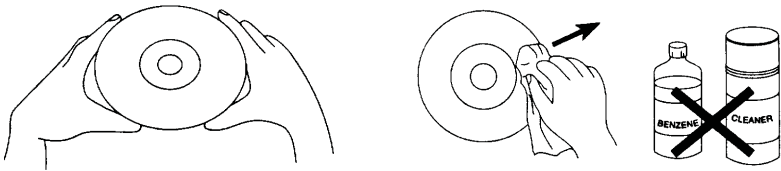

- Clean the disc periodically with a soft, lint-free, dry cloth. Never use detergents or abrasive cleaners to clean the disc. If necessary, use a CD cleaning kit.
- Never write on or affix labels to the surface of compact discs.

CARE OF THE CABINETS

- If the cabinets become dusty wipe them with a soft dry dust cloth. Do not use any wax or polish sprays on the cabinets.
- If the front panel becomes dirty or smudged with fingerprints it may be cleaned with a soft cloth slightly dampened with a mild soap and water solution. Never use abrasive cloths or polishes as these will mar the finish of your unit.

Caution: Never allow any water or other liquids to get inside the unit while cleaning.

TROUBLESHOOTING GUIDE

Symptom	Possible Problem	Solution
The unit does not respond (no power)	AC cord is not plugged into a wall outlet	Plug the AC cord into a wall outlet.
	Wall outlet is not functioning.	Plug another device into the same outlet to confirm the outlet is working.
AM band is too noisy	The reception at the set location is poor.	Slightly rotate the unit for the best reception.
Radio paused about 1 second when switch from phonograph mode to tuner mode	This is normal.	Radio will resume normal function in 1~2 seconds.
Sound is distorted	Volume level is set too high	Decrease the volume.
	Sound source is distorted.	Try a different audio source such as a music CD.
		Change the EQ setting.
CD Player does not play.	CD mode is not selected	Slide the FUNCTION switch to select CD mode.
	CD is not installed or installed incorrectly	Press the CD onto spindle, printed side facing up.
CD skips while playing	Disc is dirty or scratched.	Wipe with cloth or another disc.
Unit gets warm after extended play at high volume	This is normal.	Turn the unit off for a period of time or lower volume.

SPECIFICATIONS

Power Requirement

Main unit:	AC120V/60Hz
Remote Control	2 X 1.5V 'AAA' (UM-4) size batteries

Frequency Range

Radio Receiving	AM 530 - 1710 kHz FM 88 - 108 MHz
-----------------	--------------------------------------

Power Consumption

Main Unit:	40 Watts
------------	----------

SERVICE

Please refer to the instructions on the enclosed warranty card for returning your unit for service. When returning the unit, please remove the battery to prevent damage to the unit in transit and/or from possible battery leakage. We are not responsible for battery returned with the product or for the cost of replacement.

Distributed by:

Spectra Merchandising International, Inc.
Chicago Industry Tech Park
4230 North Normandy Avenue
Chicago, IL 60634, U.S.A.

Please have model number ready, for Customer Service, call 1-800-777-5331

The specification and external appearance of the set are subject to change without prior notice.

PRINTED IN CHINA